

# Field Guide

## F3 Detector

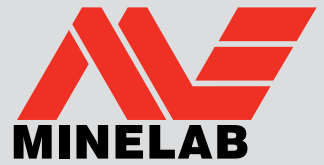

### Operation

1.

Switch On

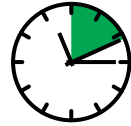
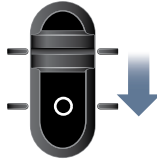
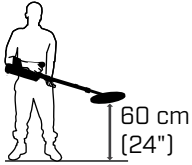

12 seconds



2.

Ground Balance

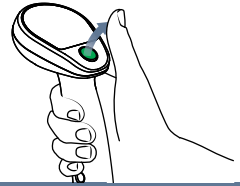
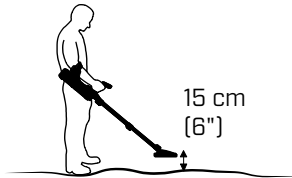
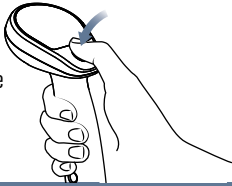

3.

Test Piece

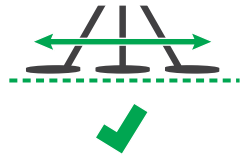
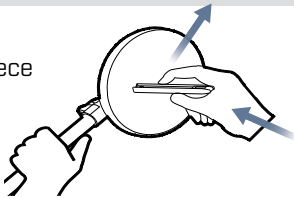

4.

Audio Reset

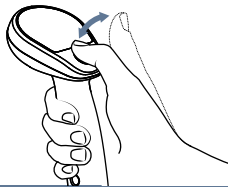

5.

Noise Cancel

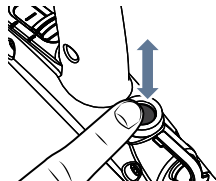
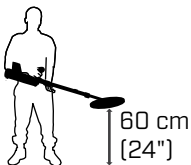
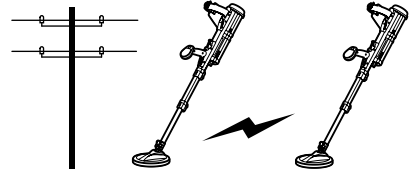

45 seconds



# F3 Configuration

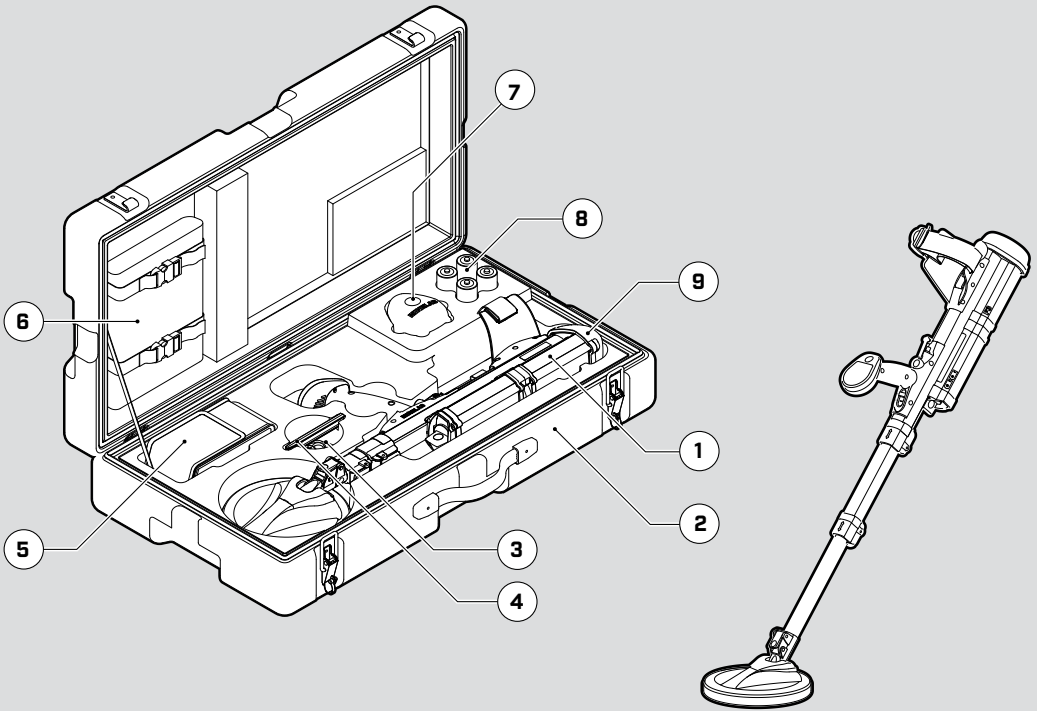

- |   |  |
|---|--|
| 1. F3 Detector  | 5. Battery Pack Bag and Extension Cable (Optional) |
| 2. Field Guide and Operations Manual<br>(Underneath detector) | 6. Soft Carry Bag                                  |
| 3. Earset (Underneath Test Piece)                             | 7. Red Endcap (Low Sensitivity F3)                 |
| 4. Test Piece   | 8. Batteries 4 × D Cell                            |
|   | 9. Black Endcap (High Sensitivity F3)              |



**Black**  
High Sensitivity  
(Default  
Endcap)



**Red**  
Reduced  
Sensitivity



**Yellow**  
Detector Settings  
Customisable  
Via PC